



PARTS BREAKDOWN PRESSURE WASHER

MODEL: B4014KABG



BEPOWEREQUIPMENT

.COM



PARTS BREAKDOWN PRESSURE WASHER

MODEL: B4014KABG

ACCESSORIES COMPONENTS

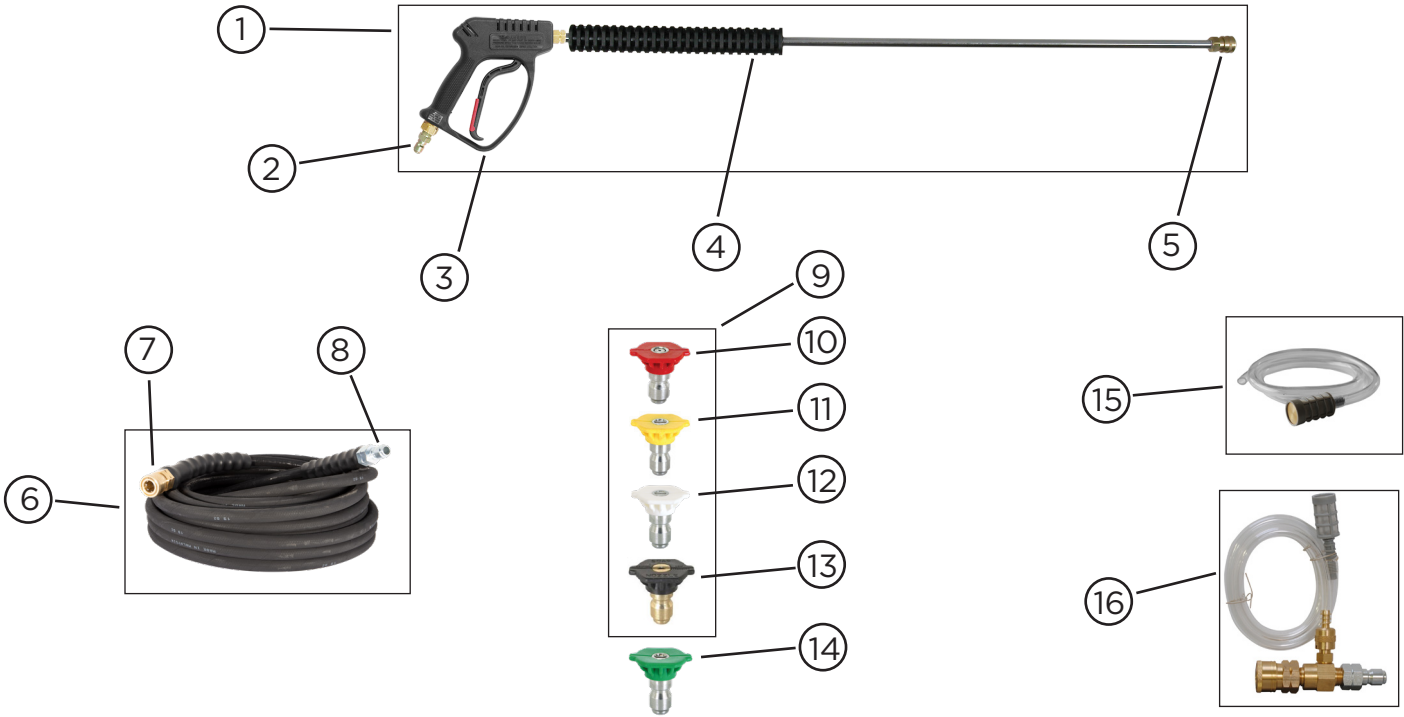

REF #	DESCRIPTION	QTY	BE PART #
1	SPRAY GUN-WAND ASSEMBLY	1	85.205.026
2	SPRAY GUN PLUG	1	85.300.105
3	SPRAY GUN	1	85.202.109
4	SPRAY WAND	1	85.202.026
5	SPRAY GUN 1/4" COUPLER	1	85.205.102
6	50' X 3/8" HOSE ASSEMBLY	1	85.238.155
7	3/8" HOSE COUPLER	1	85.300.103
8	3/8" HOSE PLUG	1	85.300.104
9	4 PIECE SPRAY NOZZLE SET, 040 ORIFICE	1	85.210.040
10	0° RED SPRAY NOZZLE, 040 ORIFICE	1	85.201.040
11	15° YELLOW SPRAY NOZZLE, 040 ORIFICE	1	85.216.040
12	40° WHITE SPRAY NOZZLE, 040 ORIFICE	1	85.241.040
13	BLACK SOAPER NOZZLE	1	85.266.040
14	25° GREEN SPRAY NOZZLE, 040 ORIFICE (OPTIONAL)	1	85.226.040
15	SOAP PICK-UP TUBE WITH FILTER	1	85.400.005
16	SOAP INJECTOR ASSEMBLY	1	85.400.000



PARTS BREAKDOWN PRESSURE WASHER

MODEL: B4014KABG

UNIT COMPONENTS

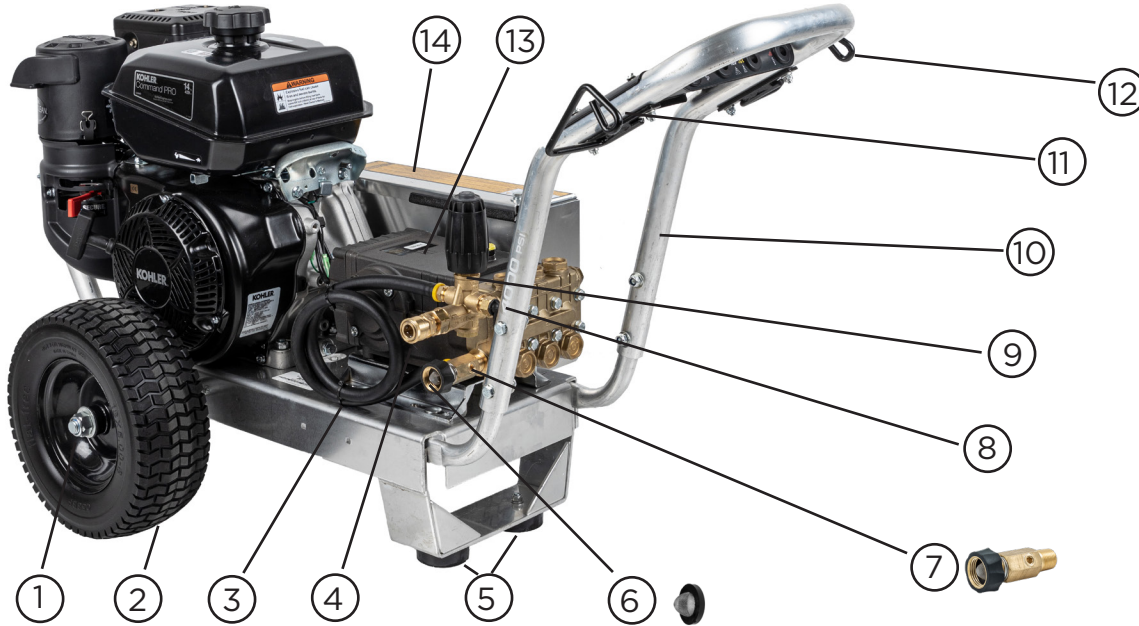

REF #	DESCRIPTION	QTY	BE PART #
1	WHEEL AXLE NUTS	2	09.000.018
2	12" FLAT FREE WHEEL	2	85.660.053BF
3	36" BY-PASS HOSE	1	85.202.078
4	3/8" PUMP OUTLET COUPLER	1	85.300.108
5	ANTI-VIBRATION FOOT PADS	2	85.660.009
6	INLET FILTER	1	85.308.120
7	INLET GARDEN HOSE FILTER FITTING	1	85.300.056
8	THERMAL RELIEF VALVE	1	85.300.023
9	UNLOADER ASSEMBLY	1	85.300.037
10	FRAME ASSEMBLY (WHEELS NOT INCLUDED)	1	85.600.088A
11	RIGHT HAND HANGER BRACKET	1	85.601.127R
12	LEFT HAND HANGER BRACKET	1	85.601.127L
13	COMPLETE PUMP ASSEMBLY - GENERAL TSS1511	1	85.139.005AB
14	BELT GUARD ASSEMBLY	1	85.602.088
15	35.5" COGGED BELT (NOT SHOWN)	1	47.002.035
16	2.65" ENGINE PULLEY (NOT SHOWN)	1	85.603.054
17	1" ENGINE BUSHING JA (NOT SHOWN)	1	85.603.055
18	TENSIONER WITH HARDWARE (NOT SHOWN)	1	85.601.088
19	6" PUMP PULLEY (NOT SHOWN)	1	85.603.057
20	24MM PUMP BUSHING SDS (NOT SHOWN)	1	85.603.056

***CHECK WITH KOHLER FOR COMMAND-PRO CH440 ENGINE BREAKDOWN AND PARTS**



PARTS BREAKDOWN PRESSURE WASHER

MODEL: B4014KABG

PUMP BREAKDOWN

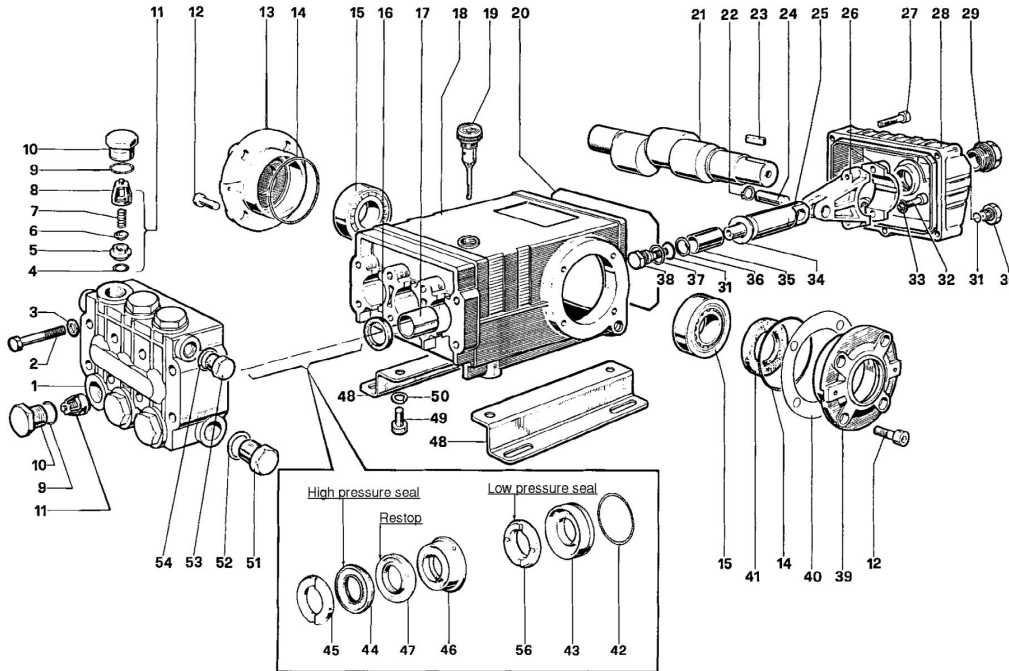

PART LIST

ITEM	PART NO.	DESCRIPTION	QTY.	ITEM	PART NO.	DESCRIPTION	QTY.	ITEM	PART NO.	DESCRIPTION	QTY.
1.	47120841	Manifold, Brass	1	19.	98210600	Oil Dip Stick	1	37.	96728000	Washer	3
	47120941	Manifold, Nickel-plated (TS2011-N)	1	20.	90392200	O-ring, Cover	1	38.	47219566	Screw, Plunger	3
2.	99320600	Screw, M8 x 70	8	21.	47021835	Crankshaft	1	39.	47150022	Cover, Crankcase	1
3.	203476	Washer, M8.4	8	22.	90055700	Ring, Snap	6	40.	97567800	Shim	2
4.	701115	O-ring, .674x.103	6	23.	640048	Key	1	41.	90164800	Seal, Oil	1
5.	36200366	Seat, Valve	6	24.	97738000	Pin, Wrist	3	42.	90361600	O-ring, 1.364x.070	3
6.	36711501	Plate, Valve	6	25.	47050554	Guide, Plunger	3	43.	47080570	Retainer, Packing	3
7.	94737600	Spring	6	26.	47030001	Rod, Connecting	3	44.	90270500	Packing	3
8.	36200251	Guide, Valve	6	27.	99191200	Screw, M6x30	5	45.	47100051	Ring, Head, M20	3
9.	701002	O-ring, .797x.103	6		99183700	Screw, M6x14 (TS1011)	5	46.	47216970	Intermed. Ring	3
10.	98222000	Cap	6	28.	47160122	Cover, Crankcase	1	47.	90270400	Restop Ring	3
	98222200	Cap, Ni-Pltd. (TS2011-N)	6		47160022	Cover, Crankcase (TS1011)	1	48.	47200074	Pump Feet	2
11.	100381	Valve Assembly	6	29.	97596800	Oil Indicator	1	49.	99364400	Screw, M10x18	4
12.	99303900	Screw, M8x16	8	30.	98204100	Cap	1	50.	96710600	Washer, M10.2	4
13.	47150122	Cover, Crankcase	1	31.	701013	O-ring, .426x.070	4	51.	98217600	Cap	1
14.	701147	O-ring, 2.675x.103	2	32.	99309900	Screw, M8x35	6	52.	96751400	Washer, M21.5	1
15.	640047	Bearing, Roller	2	33.	96701400	Washer, M8.4	6	53.	98210000	Cap	1
16.	90162500	Seal, Oil	3	34.	96728600	Washer, M14	3	54.	96738000	Washer, M17.5	1
17.	90912600	Bushing	3	35.	47040409	Plunger (20mm)	3	56.	90271000	Seal, L.P. 20mm.	3
18.	47010522	Crankcase	1	36.	660067	Ring, Back-up	3				

REPAIR KITS

KIT NO.	1	2	3	4	5	6	7	10	28	69	71
ITEM NO's INCLUDED IN KIT	4, 5, 6, 7, 8, (11)	16	41	9, 10	9, 10	31, 34, 36, 37, 38	45	42, 43	43, 43, 44, 45, 46, 47, 56	44, 47, 56	46, 47
NUMBER OF ASSEMBLIES IN KIT	6	3	2	6	6	3	6	3	1	3	3
NUMBER OF CYLINDERS KIT WILL SERVICE	3	3	-	3	3	3	3	3	1	3	3

TORQUE SPECS*

Pos.	Ft/lb	N-M
2	22.1	30
10	95.9	130
12	14.7	20
27	7.3	10
29	8.8	12
30	14.7	20
32	14.7	20
38	14.7	20
49	29.4	40
51	29.4	40
53	29.4	40

* Decrease torque by 20% if threads are lubricated

BE

POWER EQUIPMENT

If you need technical assistance call:

1-866-850-6662

(8:00am - 4:30pm PST, Mon - Fri)